

Features

- Very low supply current
- Photo detector and preamplifier in one package
- Internal filter for PCM frequency
- Improved shielding against EMI
- Supply voltage: 2.5 V to 5.5 V
- Improved immunity against ambient light
- Insensitive to supply voltage ripple and noise
- Material categorization: For definitions of compliance



Application

- TV, VCR, AUDIO, SET TOP BOX
- Home Appliances
- Remote Control Equipment

Description

These products are miniaturized receivers for infrared remote control systems. A PIN diode and a preamplifier are assembled on a lead frame, the epoxy package acts as an IR filter.

The demodulated output signal can be directly decoded by a microprocessor. The VS1838B is compatible with all common IR remote control data formats and can suppress almost all spurious pulses from energy saving fluorescent lamps.

This component has not been qualified according to automotive specifications.

◆ Block Diagram

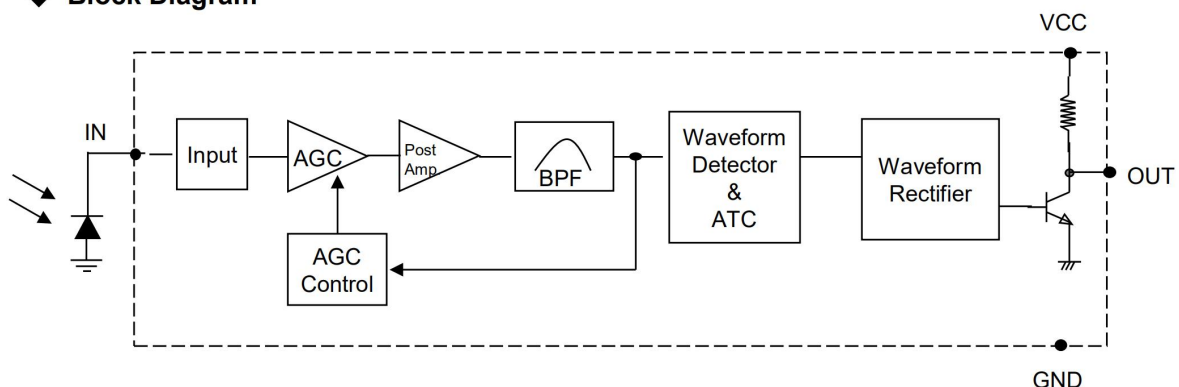

PACKAGE DIMENSIONS

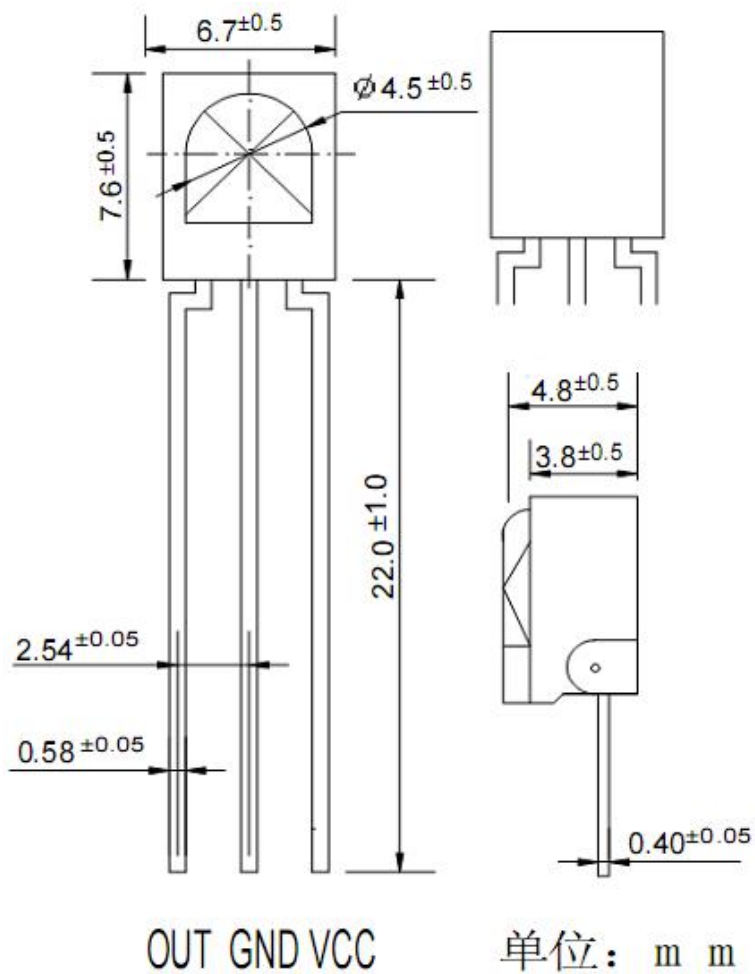

NOTES:

1. All dimensions are in millimeters (inches).
2. Tolerance is $\pm 0.2\text{mm}$ (.010") unless otherwise noted.
3. Lead spacing is measured where the leads emerge from the package.

Absolute Maximum Ratings (T_a=25°C)

Parameter	Symbol	Rating	Unit
Supply Voltage	V _{cc}	6	V
Operating Temperature	T _{opr}	-25 ~ +85	°C
Storage Temperature	T _{stg}	-40 ~ +85	°C
Soldering Temperature *1	T _{sol}	260	°C

*1 4mm from mold body less than 10 seconds

Electro-Optical Characteristics (T_a=25°C and V_{cc}=3.0V)

Parameter	Symbol	MIN.	TYP.	MAX.	Unit	Condition
Consumption Current	I _{cc}	---	---	2	mA	No signal input
B.P.F Center Frequency	F _o	---	38	---	KHz	
Peak Wavelength	λ _p	---	940	---	nm	
Reception Distance	L ₀	14	---	---	m	At the ray axis Notes 1
	L ₄₅	6	---	---		
Half Angle(Horizontal)	Θ _h	---	45	---	deg	
Half Angle(Vertical)	Θ _v	---	45	---	deg	
High Level Pulse Width	T _H	400	---	800	μs	At the ray axis Notes 2
Low Level Pulse Width	T _L	400	---	800	μs	
High Level Output Voltage	V _H	2.7	---	---	V	
Low Level Output Voltage	V _L	---	0.2	0.5	V	

*2. The ray receiving surface at a vertex and relation to the ray axis in the range of θ=0° and θ=45°.

*3. A range from 30cm to the arrival distance. Average value of 50 pulses.

Measurement Conditions (Ta=25°)

[Fig.1] Output Waveform (at freq.=37.9KHz)

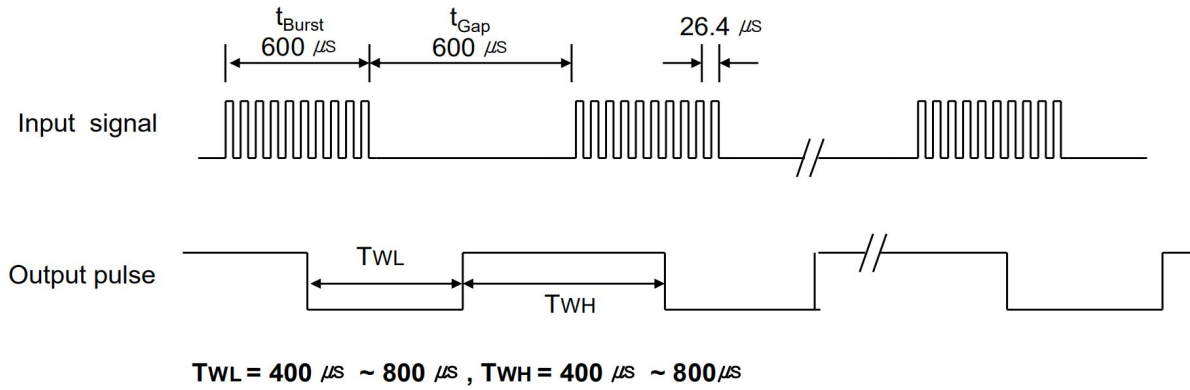

[Fig.2] Transmitter

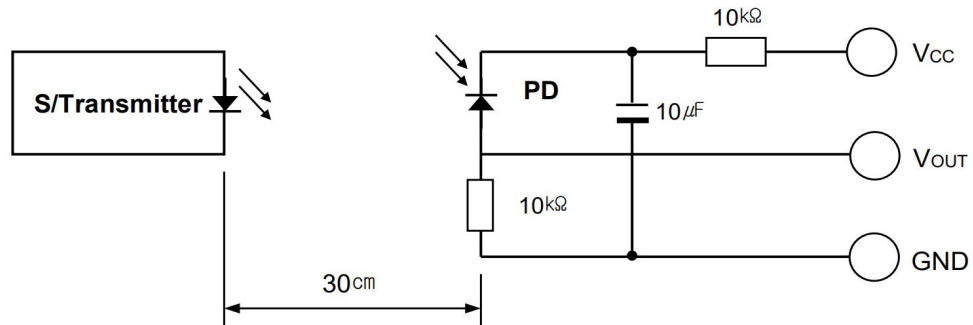

※ The specifications shall be satisfied under the following conditions. The standard transmitter shall be specified of the burst wave form adjusted to V_{OUT} 200mVp-p upon P_o measuring circuit Standard Transmitter

[Fig.3] Test condition of arrival distance

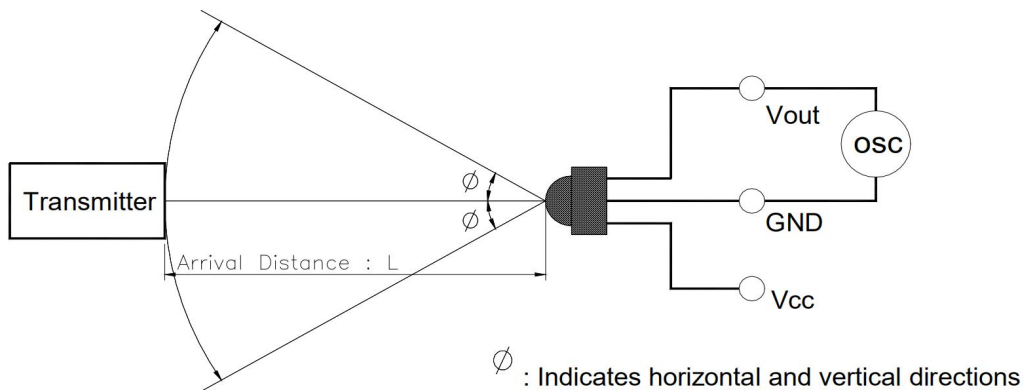

[Measurement condition for arrival distance]

☞ Ambient light source : Detecting surface illumination shall be irradiate $200 \pm 50 \text{Lux}$ under ordinary white fluorescence lamp without high frequency lighting

Electrical / Optical Characteristics (Ta=25°)

[Fig.4] Supply Current vs. Voltage

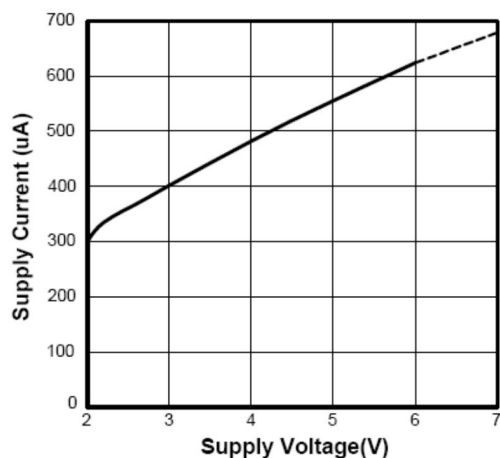

[Fig.5] Relative Spectral Sensitivity

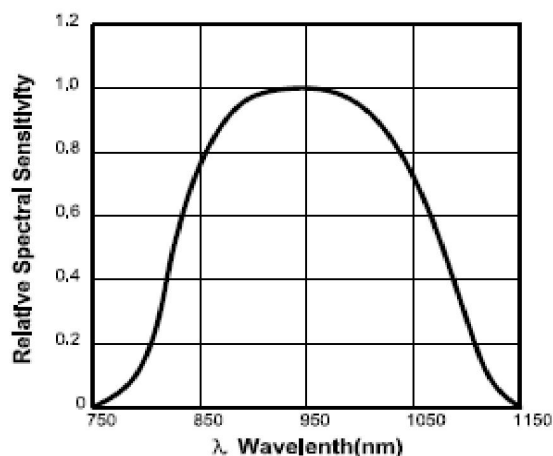

[Fig.6] Output Pulse Width vs. Distance

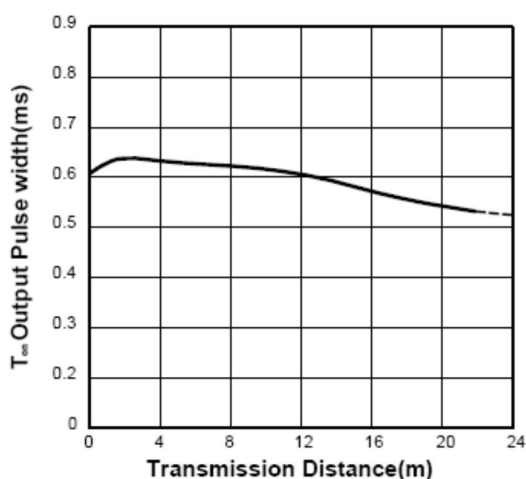

[Fig.7] Directivity

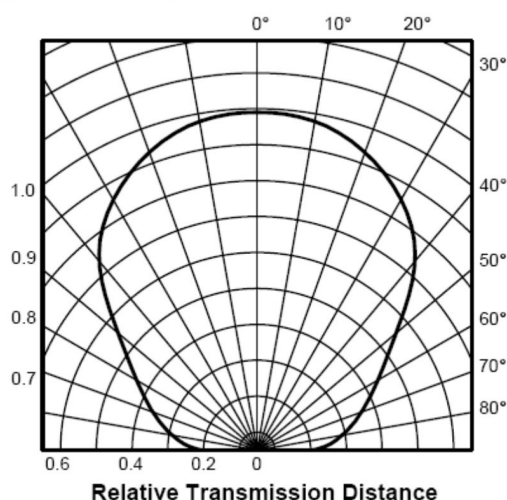

[Fig.8] B.P.F Fc Curve

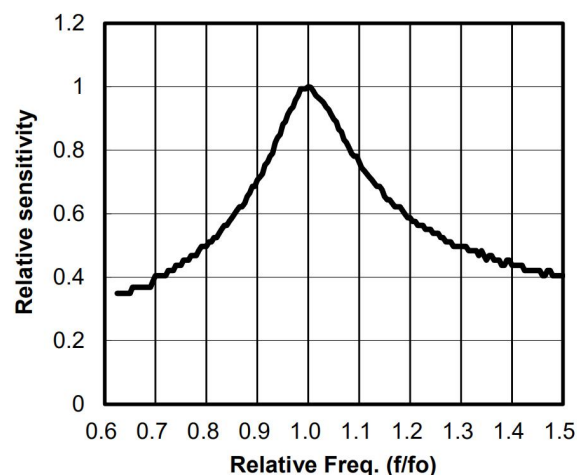

ESD Test Results

Parameter	Specification	Results
Machine Model	Min ±200V	> ±400V
Human Body Model	Min ±2000V	> ±4000V
Charged Device Model	Min ±400V	> ±600V

Item	Symbol	Time
Minimum Data word length	-	Max. 100ms
Minimum Burst length	t_{Burst}	Min. 300us
Minimum Gap Time	t_{Gap}	Min. 350us
Minimum data pause time	t_{Pause}	Min. 50ms
Required data pause time	$t_{Pause} > \{ (\sum t_{Burst} * 2) / 2.5 \} + 30$	

* note 1)

: t_{Pause_min} Could be changed by different data word format.

Therefore, for new application on sets please refer to "Required data pause time(t_{Pause})" on above.

[Fig. 9] Data Signal diagram

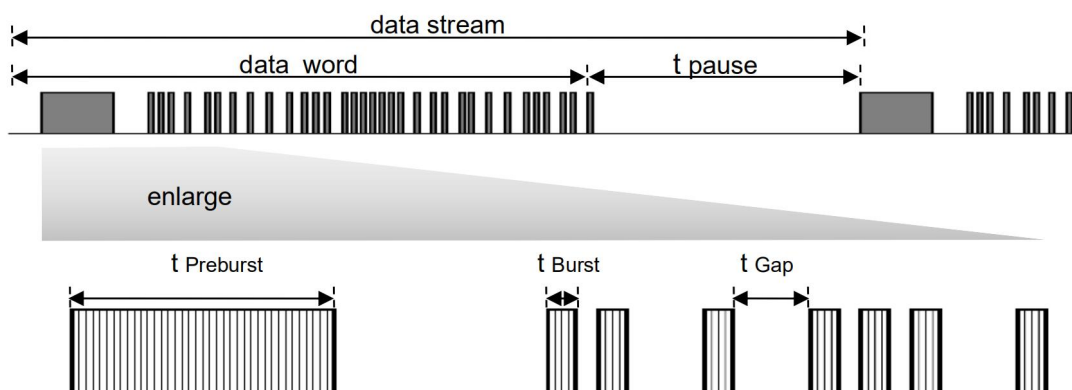

- t_{Burst} ; length of a burst in pulses of the carrier frequency.
- t_{Gap} ; length of the gap between two burst in pulses of carrier.
- t_{pause} ; length of the pause between two data words.
- $t_{Preburst}$; lead code of data word

External Application Circuit - Power Noise reduction & ESD Protection

A further influence to the IR receiver modules may come from a supply voltage which is not stable. Such a disturbed supply voltage can be caused by switching power supply.

which is not filtered well or by other components in the circuit which produced spikes on the supply line.

This disturbed supply will reduce the sensitivity of receiver modules.

This application circuit will filter the disturbed supply voltage.

[Fig 10] Application for power supply ripple suppression

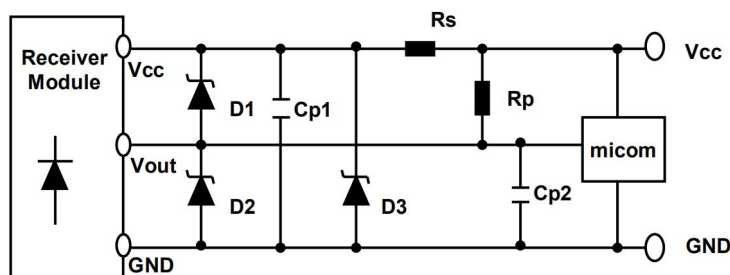

Component	Recommend
1) R_s	Typ. 100ohm (47 Ω ~470 Ω)
2) C_{p1}	Typ. 100uF (47uF~100uF)
3) R_p	Optional (10k Ω or more)
4) C_{p2}	Typ. 1nF (1nF ~ 10nF)
5) $D1$ ~ $D3$	Zener diode or TVS (ESD Protection device)

Reliability Test Items

Parameter	Test conditions	Remark
High Temperature	Ta=+85, Vcc=5.0V t=240h	※ 1, ※ 2
Low Temperature	Ta=-30, Vcc=5.0V t=240h	※ 1, ※ 2
High Temp./ High Humidity	Ta=+85℃ 85%RH, Vcc=5.0V t=240h	※ 1, ※ 2
Heat Cycle	Ta=-20℃(0.5h) to +85℃(0.5h) 20 cycle	※ 2, ※ 3
Fall Test	Height=75cm, 3 times	※ 4

- ※ 1. Supply voltage of load test is 5V.
- ※ 2. Electro-optical characteristics shall be satisfied after leaving 2 hours in the normal condition.
- ※ 3. Heat cycle test shall repeat above condition 20 times under no load.
- ※ 4. The test devices shall be dropped three time on the hard wooden board from a height of 75cm.

Material Configuration

Parameter	Configuration	Remark
IC	Silicon(99%)	
Photo diode	Silicon(99%)	
Lead frame	Copper(99.5%), Silver(0.5%)	
Epoxy resin	Resin(55.5%), Hardener(45.5%)	
Silver epoxy	Silver(80%), Resin(10%), Hardener(10%)	
Bond wire	Gold(99.99%)	

Lead(Pb)-Free Reflow Solder Profile

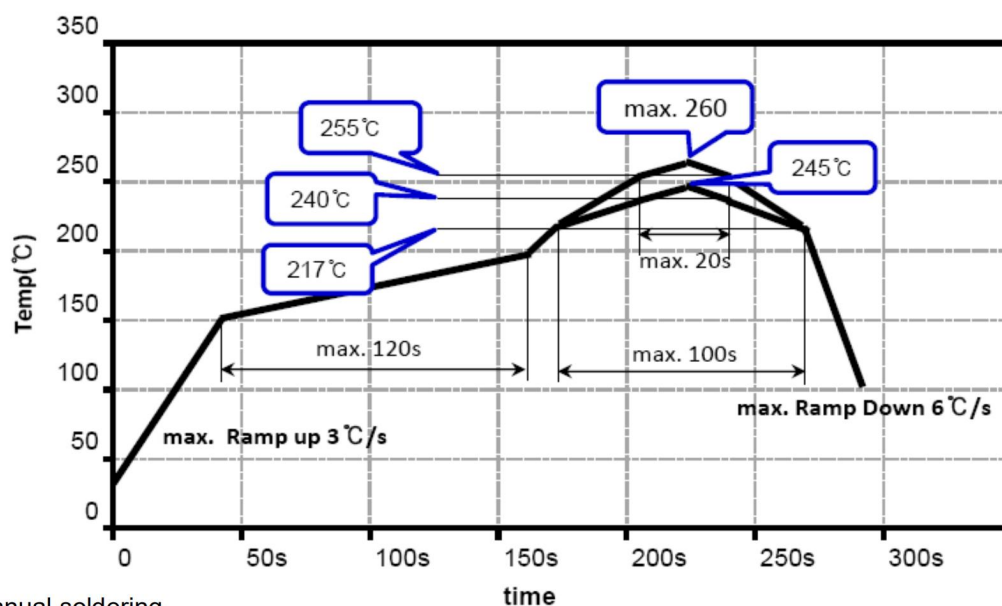

- ※ Manual soldering
- Use a soldering iron of 25W or less. Adjust the temperature of the soldering iron below 260 °C.

Packing Quantity Specification

1. 250Pcs/1Bag,20 Bag/1Box
2. 4Boxes/1Carton

Label Form Specification

製品名 PRODUCT	
コードNo. CODE No.	
数量 Q'TY	
ロットNo. LOT No.	
備考 REMARKS	
	

- PRODUCT: Part Number
- CODE NO.: Product Serial Number
- QTY: Packing Quantity
- LOT No: Lot Number
- REMARKS:Remarks

Legal Disclaimer Notice

ALL PRODUCT, PRODUCT SPECIFICATIONS AND DATA ARE SUBJECT TO CHANGE WITHOUT NOTICE TO IMPROVE RELIABILITY, FUNCTION OR DESIGN OR OTHERWISE.

SIVAGO SEMICONDUCTOR CO.,LTD its affiliates, agents, and employees, and all persons acting on its or their behalf (collectively,“SIVAGO”), disclaim any and all liability for any errors, inaccuracies or incompleteness contained in any datasheet or in any other disclosure relating to any product.

SIVAGO makes no warranty, representation or guarantee regarding the suitability of the products for any particular purpose or the continuing production of any product. To the maximum extent permitted by applicable law, SIVAGO disclaims (i) any and all liability arising out of the application or use of any product, (ii) any and all liability, including without limitation special,consequential or incidental damages, and (iii) any and all implied warranties, including warranties of fitness for particular purpose, non-infringement and merchantability.

Statements regarding the suitability of products for certain types of applications are based on SIVAGO’s knowledge of typical requirements that are often placed on SIVAGO products in generic applications. Such statements are not binding statements about the suitability of products for a particular application. It is the customer’s responsibility to validate that a particular product with the properties described in the product specification is suitable for use in a particular application.Parameters provided in datasheets and / or specifications may vary in different applications and performance may vary over time. All operating parameters, including typical parameters, must be validated for each customer application by the customer’s technical experts. Product specifications do not expand or otherwise modify SIVAGO’s terms and conditions of purchase,including but not limited to the warranty expressed therein.

Except as expressly indicated in writing, SIVAGO products are not designed for use in medical, life-saving, or life-sustaining applications or for any other application in which the failure of the SIVAGO product could result in personal injury or death.Customers using or selling SIVAGO products not expressly indicated for use in such applications do so at their own risk.Please contact authorized SIVAGO personnel to obtain written terms and conditions regarding products designed for such applications.

No license, express or implied, by estoppel or otherwise, to any intellectual property rights is granted by this document or by any conduct of SIVAGO. Product names and markings noted herein may be trademarks of their respective owners.