

## Features

Fast response times

High photo sensitivity

Small junction capacitance

Pb free

The product itself will remain within RoHS compliant version

Compliance with EU REACH



## Application

High speed photo detector

Camera

Optoelectronic switch

VCRs , Video camera

## Description

PD400B is a high speed and sensitive PIN photodiode in a cylindrical side view plastic package. The epoxy package itself is an IR filter , spectrally matched to IR emitter.

## PACKAGE DIMENSIONS

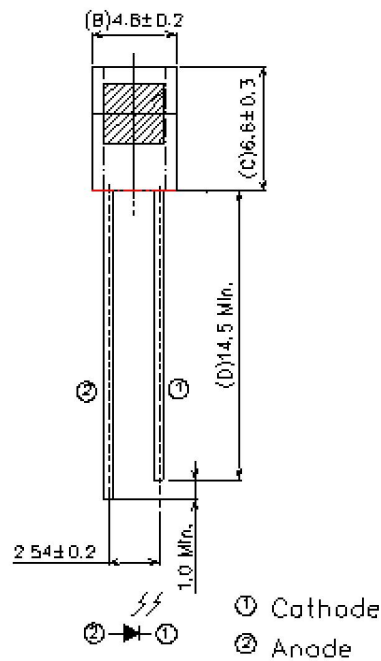
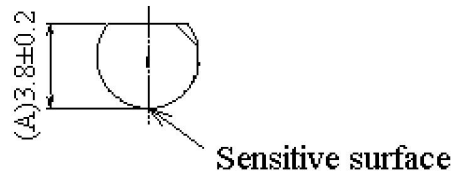

### NOTES:

1. All dimensions are in millimeters (inches).
2. Tolerance is  $\pm 0.25\text{mm}(.010\text{'})$  unless otherwise noted.
3. Lead spacing is measured where the leads emerge from the package.

**ABSOLUTE MAXIMUM RATINGS AT TA =25°C**

Parameter	Symbol	Rating	Unit
Reverse Voltage	V <sub>R</sub>	32	mA
Power Dissipation	P <sub>d</sub>	150	mW
Operating Temperature	T <sub>opr</sub>	-40 ~ +85	°C
Storage Temperature	T <sub>stg</sub>	-40 ~ +100	°C
Soldering Temperature(*1)	T <sub>sol</sub>	260	°C

**Notes:** \*1 Soldering time ≤ 5 seconds

**ELECTRICAL OPTICAL CHARACTERISTICS AT TA=25°C**

Parameter	Symbol	Min.	Typ.	Max.	Unit	Condition
Rang of Spectral Bandwidth	$\lambda_{0.5}$	400	-----	1100	nm	-----
Wavelength of Peak Sensitivity	$\lambda_p$	-----	940	-----	nm	-----
Open-Circuit Voltage	VOC	-----	0.35	-----	V	Ee=5m W/cm <sup>2</sup> $\lambda_p=940\text{nm}$
Short- Circuit Current	ISC	-----	18	-----	uA	Ee=1m W/cm <sup>2</sup> $\lambda_p=940\text{nm}$
Reverse Light Current	$I_L$	10.2	18	-----	uA	Ee=1m W/cm <sup>2</sup> $\lambda_p=940\text{nm}$ VR=5V
Dark Current	$I_d$	----	5	30	nA	Ee=0m W/cm <sup>2</sup> VR=10V
Reverse Breakdown	BVR	32	170	-----	V	Ee=0m W/cm <sup>2</sup> IR=100 $\mu$ A
Total Capacitance	Ct	----	25	----	pF	Ee=0m W/cm <sup>2</sup> VR=3V f=1MHZ
Rise/Fall Time	tr/tf	----	50/50	----	nS	VR=10V RL=1K $\Omega$

## Typical Electro-Optical Characteristics Curves

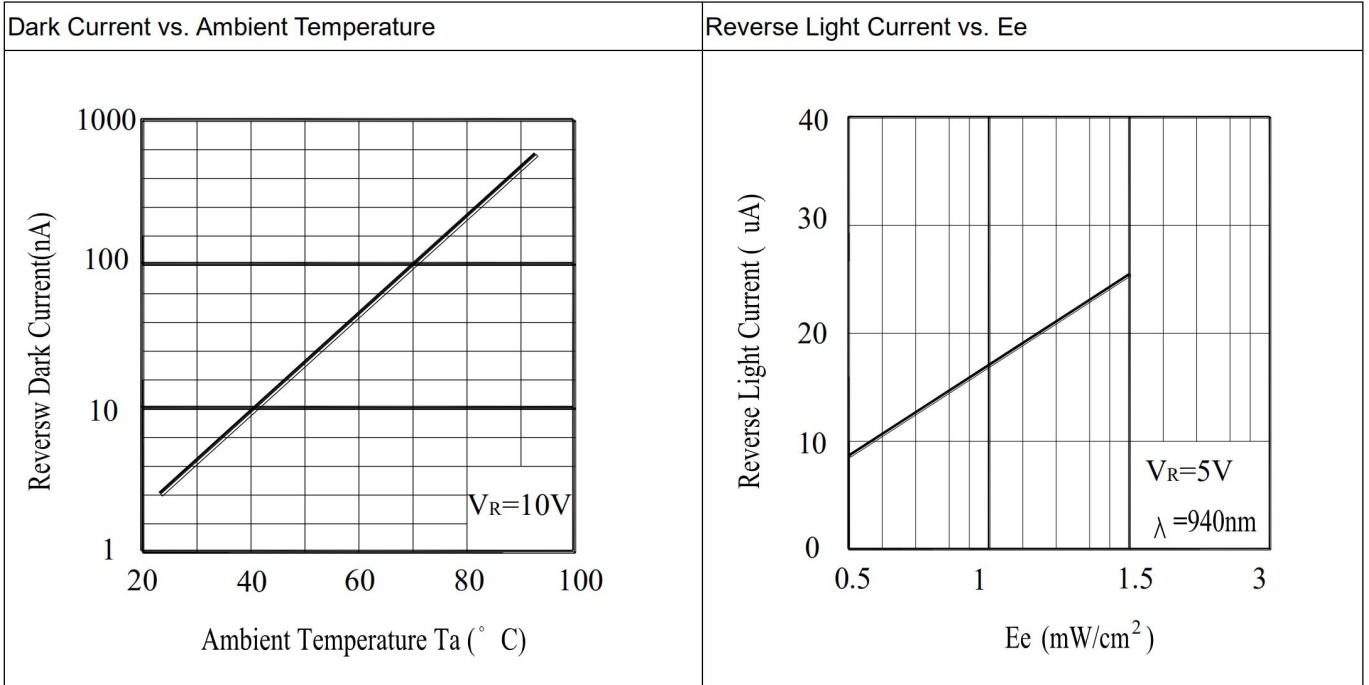
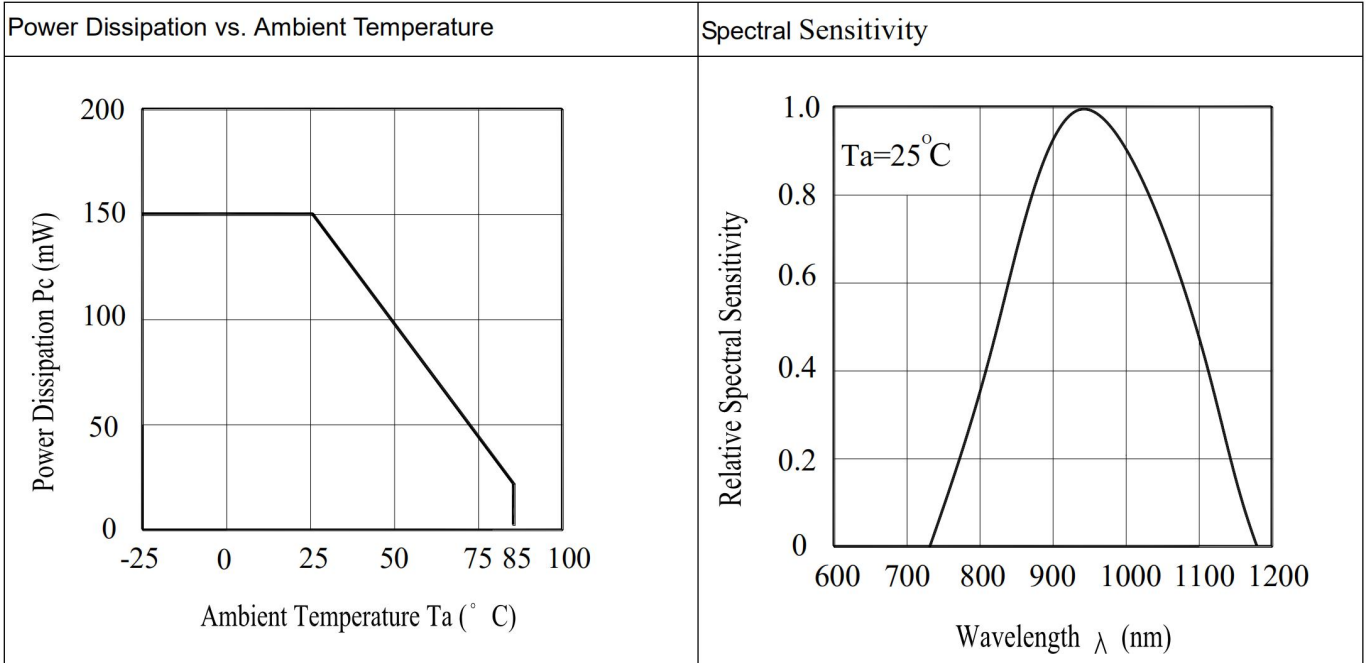

Terminal Capacitance vs. Reverse Voltage

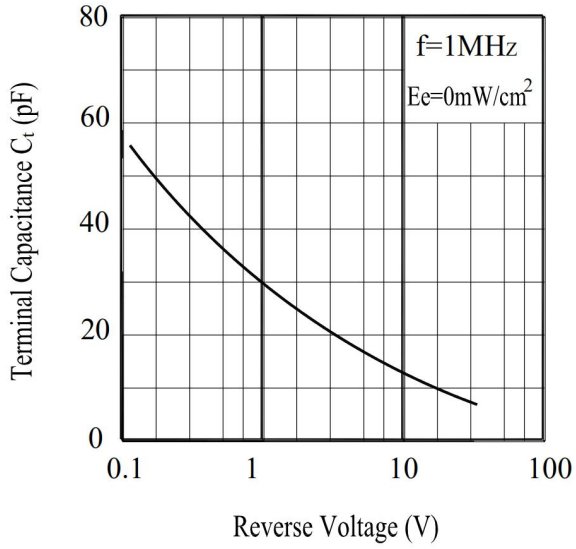

Response Time vs. Load Resistance

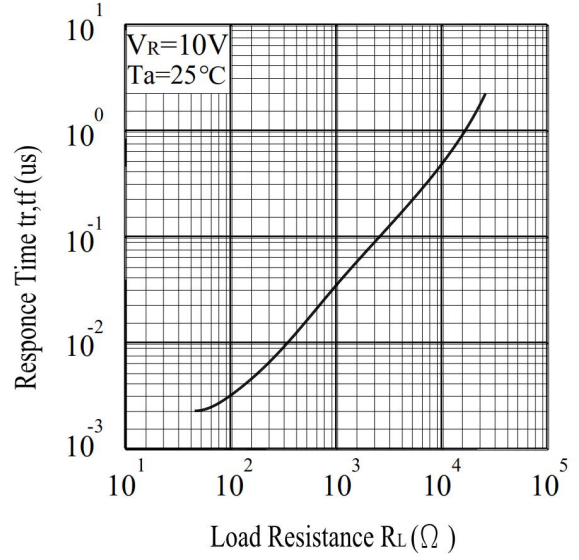

**Packing Quantity Specification**

1. 1000Pcs/1Bag, 10 Bag/1Box
2. 4Boxes/1Carton

**Label Form Specification**

製品名 PRODUCT	
コードNo. CODE No.	
数量 Q'TY	
ロットNo. LOT No.	
備考 REMARKS	
	

- PRODUCT: Part Number
- CODE NO.: Product Serial Number
- QTY: Packing Quantity
- LOT No: Lot Number
- REMARKS:Remarks

**Notes****Lead Forming**

1. During lead frame bending, the lead frame should be bent at a distance more than 3mm from bottom of the epoxy.

Note: Must fix lead frame and do not touch epoxy before bending to avoid Photodiode broken.

2. Lead forming should be done before soldering.

3. Avoid stressing the Photodiode package during leads forming. The stress to the base may damage the Photodiode's characteristics or it may break the Photodiode.

4. Cut the Photodiode lead frame at room temperature. Cutting the lead frame at high temperatures may cause failure of the Photodiode.

5. When mounting the Photodiode onto a PCB, the PCB holes must be aligned exactly with the lead position of the Photodiode. If the Photodiode are mounted with stress at the leads, it causes deterioration of the epoxy resin and this will degrade the Photodiode.

## Soldering

- Careful attention should be paid during soldering. When soldering, leave more than 3mm from solder joint to epoxy bulb, and soldering beyond the base of the tie bar is recommended.
- Recommended soldering conditions:

Hand Soldering		DIP Soldering	
Temp. at tip of iron	300°C Max. (30W Max.)	Preheat temp.	100°C Max. (60 sec Max.)
Soldering time	3 sec Max.	Bath temp. & time	260 Max., 5 sec Max
Distance	3mm Min.(From solder joint to epoxy bulb)	Distance	3mm Min. (From solder joint to epoxy bulb)

### 3. Recommended soldering profile

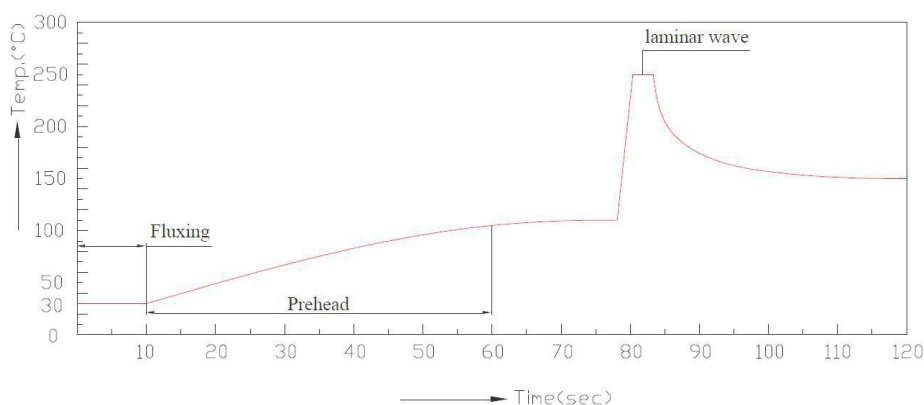

- Avoiding applying any stress to the lead frame while the Photodiode are at high temperature particularly when soldering.
- Dip and hand soldering should not be done more than one time
- After soldering the Photodiode, the epoxy bulb should be protected from mechanical shock or vibration until the Photodiode return to room temperature.
- A rapid-rate process is not recommended for cooling the Photodiode down from the peak temperature.
- Although the recommended soldering conditions are specified in the above table, dip or hand soldering at the lowest possible temperature is desirable for the Photodiode.
- Wave soldering parameter must be set and maintain according to recommended temperature and dwell time in the solder wave.



## Legal Disclaimer Notice

**ALL PRODUCT, PRODUCT SPECIFICATIONS AND DATA ARE SUBJECT TO CHANGE WITHOUT NOTICE TO IMPROVE RELIABILITY, FUNCTION OR DESIGN OR OTHERWISE.**

SIVAGO SEMICONDUCTOR CO.,LTD its affiliates, agents, and employees, and all persons acting on its or their behalf (collectively,“SIVAGO”), disclaim any and all liability for any errors, inaccuracies or incompleteness contained in any datasheet or in any other disclosure relating to any product.

SIVAGO makes no warranty, representation or guarantee regarding the suitability of the products for any particular purpose or the continuing production of any product. To the maximum extent permitted by applicable law, SIVAGO disclaims (i) any and all liability arising out of the application or use of any product, (ii) any and all liability, including without limitation special,consequential or incidental damages, and (iii) any and all implied warranties, including warranties of fitness for particular purpose, non-infringement and merchantability.

Statements regarding the suitability of products for certain types of applications are based on SIVAGO’s knowledge of typical requirements that are often placed on SIVAGO products in generic applications. Such statements are not binding statements about the suitability of products for a particular application. It is the customer’s responsibility to validate that a particular product with the properties described in the product specification is suitable for use in a particular application.Parameters provided in datasheets and / or specifications may vary in different applications and performance may vary over time. All operating parameters, including typical parameters, must be validated for each customer application by the customer’s technical experts. Product specifications do not expand or otherwise modify Vishay’s terms and conditions of purchase,including but not limited to the warranty expressed therein.

Except as expressly indicated in writing, SIVAGO products are not designed for use in medical, life-saving, or life-sustaining applications or for any other application in which the failure of the SIVAGO product could result in personal injury or death.Customers using or selling SIVAGO products not expressly indicated for use in such applications do so at their own risk.Please contact authorized SIVAGO personnel to obtain written terms and conditions regarding products designed for such applications.

No license, express or implied, by estoppel or otherwise, to any intellectual property rights is granted by this document or by any conduct of SIVAGO. Product names and markings noted herein may be trademarks of their respective owners.