

OPTO INTERRUPTER LA230A

SIVAGO[®]
SEMICONDUCTOR

Features

- Non-contact switching.
- For direct PC board or dual-in-line socket mounting.
- Fast switching speed.



Application

- Scanner
- Edge,Position Detections
- FAX machine
- Counter

Description

The LA230A series consist of Gallium Arsenide infrared emitting diode and a NPN silicon phototransistor mounted in a black plastic housing. Phototransistor switching takes place whenever an opaque object passes through the slot. These series are designed for direct soldering into PC board or mounting in standard dual-in-line socket.

Switching time measurement circuit

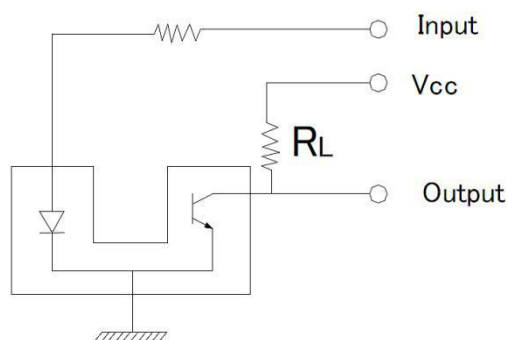

PACKAGE DIMENSIONS

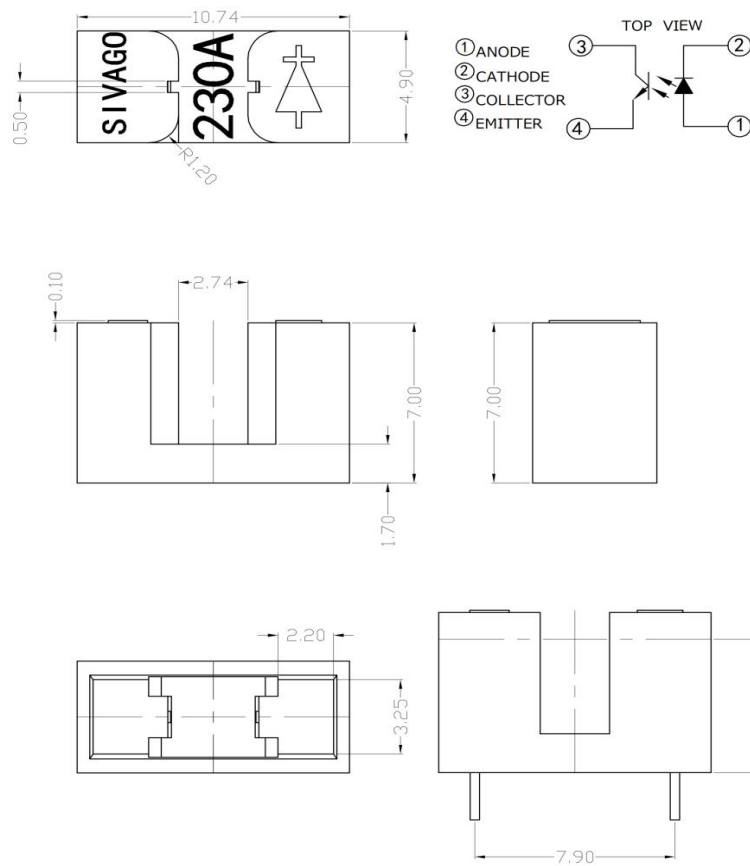

NOTES:

1. All dimensions are in millimeters (inches).
2. Tolerance is ± 0.25 mm(.010") unless otherwise noted.
3. Lead spacing is measured where the leads emerge from the package.

ABSOLUTE MAXIMUM RATINGS AT TA =25°C

PARAMETER	MAXIMUM RATING	UNIT
IR Diode Continuous Forward Current	50	mA
IR Diode Reverse Voltage	5	V
Transistor Collector Current	20	mA
Transistor Power Dissipation	100	mW
IR Diode Peak Power Current (Pulse Wide = 1μS, 300 pps)	3	A
Diode Power Dissipation	175	mW
Phototransistor Collector-Emitter Voltage	30	V
Phototransistor Emitter-Collector Voltage	5	V
Operating Temperature Range	-40°C to +85°C	
Storage Temperature Range	-50°C to +100°C	

ELECTRICAL OPTICAL CHARACTERISTICS AT TA=25°C

PARAMETER	SYMBOL	MIN.	TYP.	MAX.	UNIT	TEST CONDITION
INPUT LED						
Forward Voltage	V_F		1.2	1.35	V	$I_F=20\text{mA}$
Reverse Current	I_R			100	μA	$V_R=5\text{V}$
OUTPUT PHOTOTRANSISTOR						
Collector-Emitter Breakdown Voltage	$V_{(BR)CEO}$	30			V	$I_C=1\text{mA}$
Emitter-Collector Breakdown Voltage	$V_{(BR)CEO}$	5			V	$I_E=0.1\text{mA}$
Collector-Emitter Dark Current	I_{CEO}			100	nA	$V_{CE}=10\text{V}$
COUPLER						
Collector-Emitter Saturation Voltage	$V_{CE(SAT)}$			0.4	V	$I_C=0.2\text{mA}$ $I_F=20\text{mA}$
Current Transfer Ratio	$I_{c(on)}$	0.8			mA	$V_{CE}=5\text{V}$ $I_F=20\text{mA}$

TYPICAL ELECTRICAL / OPTICAL CHARACTERISTICS CURVES

(25°C Ambient Temperature Unless Otherwise Noted)

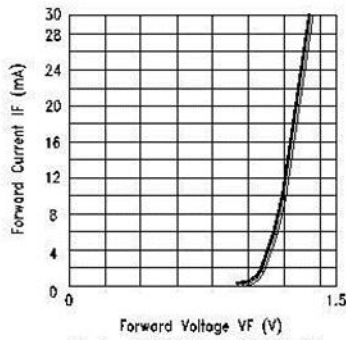

Fig.1 FORWARD CURRENT VS. FORWARD VOLTAGE

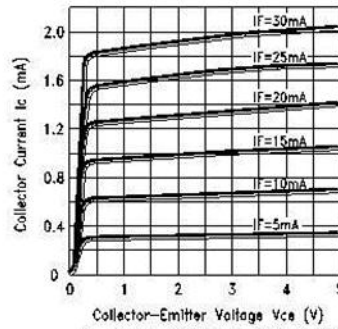

Fig.2 COLLECTOR CURRENT VS. COLLECTOR VOLTAGE

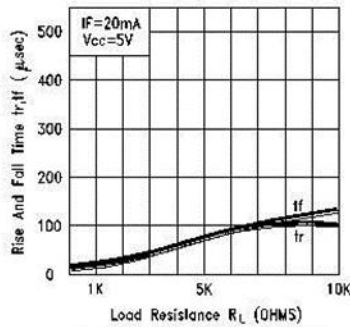

Fig.3 RISE AND FALL TIME VS. LOAD RESISTANCE

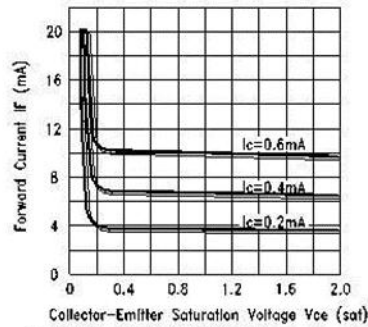

Fig.4 FORWARD CURRENT VS. Collector-Emitter Saturation Voltage

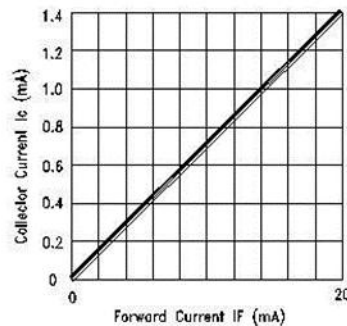



Fig.5 COLLECTOR CURRENT V.S FORWARD CURRENT

Packing Quantity Specification

1. 500Pcs/1Bag, 8 Bag/1Box
2. 4Boxes/1Carton

Label Form Specification

製品名 PRODUCT	
コードNo. CODE No.	
数量 QTY	
ロットNo. LOT No.	
備考 REMARKS	
	

- PRODUCT: Part Number
- CODE NO.: Product Serial Number
- QTY: Packing Quantity
- LOT No: Lot Number
- REMARKS:Remarks

Notes

Lead Forming

1. During lead frame bending, the lead frame should be bent at a distance more than 3mm from bottom of the epoxy.

Note: Must fix lead frame and do not touch epoxy before bending to avoid Photo Interrupter broken.

2. Lead forming should be done before soldering.

3. Avoid stressing the Photo Interrupter package during leads forming. The stress to the base may damage the characteristics of Photo Interrupter, or it may break the Photo Interrupter.

4. Cut the Photo Interrupter lead frame at room temperature. Cutting the lead frame at high temperatures may cause failure of the Photo Interrupter.

5. When mounting the Photo Interrupter onto a PCB, the PCB holes must be aligned exactly with the lead position of the Photo Interrupter. If the Photo Interrupter are mounted with stress at The leads, it causes deterioration of the epoxy resin and this will degrade the Photo Interrupter.

Soldering

- Careful attention should be paid during soldering. When soldering, leave more than 3mm from solder joint to epoxy bulb, and soldering beyond the base of the tie bar is recommended.
- Recommended soldering conditions:

Hand Soldering		DIP Soldering	
Temp. at tip of iron	300°C Max. (30W Max.)	Preheat temp.	100°C Max. (60 sec Max.)
Soldering time	3 sec Max.	Bath temp. & time	260 Max., 5 sec Max
Distance	3mm Min.(From solder joint to epoxy bulb)	Distance	3mm Min. (From solder joint to epoxy bulb)

3. Recommended soldering profile



- Avoiding applying any stress to the lead frame while the Photo Interrupter are at high temperature particularly when soldering.
- Dip and hand soldering should not be done more than one time
- After soldering the Photo Interrupter, the epoxy bulb should be protected from mechanical shock or vibration until the Photo Interrupter return to room temperature.
- A rapid-rate process is not recommended for cooling the Photo Interrupter down from the peak temperature.
- Although the recommended soldering conditions are specified in the above table, dip or hand soldering at the lowest possible temperature is desirable for the Photo Interrupter.
- Wave soldering parameter must be set and maintain according to recommended temperature and dwell time in the solder wave.

Legal Disclaimer Notice

ALL PRODUCT, PRODUCT SPECIFICATIONS AND DATA ARE SUBJECT TO CHANGE WITHOUT NOTICE TO IMPROVE RELIABILITY, FUNCTION OR DESIGN OR OTHERWISE.

SIVAGO SEMICONDUCTOR CO.,LTD its affiliates, agents, and employees, and all persons acting on its or their behalf (collectively,“SIVAGO”), disclaim any and all liability for any errors, inaccuracies or incompleteness contained in any datasheet or in any other disclosure relating to any product.

SIVAGO makes no warranty, representation or guarantee regarding the suitability of the products for any particular purpose or the continuing production of any product. To the maximum extent permitted by applicable law, SIVAGO disclaims (i) any and all liability arising out of the application or use of any product, (ii) any and all liability, including without limitation special,consequential or incidental damages, and (iii) any and all implied warranties, including warranties of fitness for particular purpose, non-infringement and merchantability.

Statements regarding the suitability of products for certain types of applications are based on SIVAGO’s knowledge of typical requirements that are often placed on SIVAGO products in generic applications. Such statements are not binding statements about the suitability of products for a particular application. It is the customer’s responsibility to validate that a particular product with the properties described in the product specification is suitable for use in a particular application.Parameters provided in datasheets and / or specifications may vary in different applications and performance may vary over time. All operating parameters, including typical parameters, must be validated for each customer application by the customer’s technical experts. Product specifications do not expand or otherwise modify SIVAGO’s terms and conditions of purchase,including but not limited to the warranty expressed therein.

Except as expressly indicated in writing, SIVAGO products are not designed for use in medical, life-saving, or life-sustaining applications or for any other application in which the failure of the SIVAGO product could result in personal injury or death.Customers using or selling SIVAGO products not expressly indicated for use in such applications do so at their own risk.Please contact authorized SIVAGO personnel to obtain written terms and conditions regarding products designed for such applications.

No license, express or implied, by estoppel or otherwise, to any intellectual property rights is granted by this document or by any conduct of SIVAGO. Product names and markings noted herein may be trademarks of their respective owners.