

5mm Infrared LED KEL-504C-FH

SIVAGO[®]
SEMICONDUCTOR

Features

High reliability

High radiant intensity

Peak wavelength $\lambda_p=940\text{nm}$

2.54mm Lead spacing

Low forward voltage

Pb Free

This product itself will remain within RoHS compliant version.



Application

Free air transmission system

Infrared remote control units with high power requirement

Smoke detector

Infrared applied system

Compliance with EU REACH

Compliance Halogen Free(Br < 900ppm, Cl < 900ppm, Br+Cl < 1500ppm)

Description

Infrared Emitting Diode (KEL-504C-FH) is a high intensity diode , molded in a water clear plastic package.The device is spectrally matched with phototransistor , photodiode and infrared receiver module.

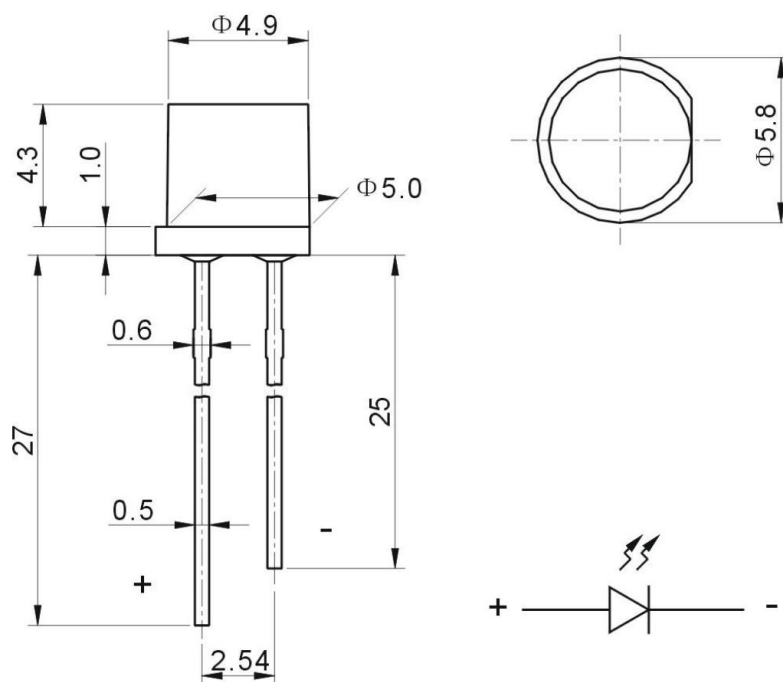
PACKAGE DIMENSIONS**NOTES:**

1. All dimensions are in millimeters (inches).
2. Tolerance is $\pm 0.25\text{mm}$ (.010") unless otherwise noted.
3. Lead spacing is measured where the leads emerge from the package.

ABSOLUTE MAXIMUM RATINGS AT TA =25°C

Parameter	Symbol	Rating	Unit
Continuous Forward Current	I _F	20	mA
Power Dissipation at (or below) 25°C Free Air Temperature	P _d	150	mW
Transient Peak Current (Pulse width=100 μs, Duty cycle=1%)	I _{FP}	200	mA
Reverse Voltage	V _R	5	V
Operating Temperature	T _{opr}	-40~+85	°C
Storage Temperature*	T _{stg}	-40~+85	°C
Soldering Temperature	T _{sol}	260	°C

Notes: *1:I_{FP} Conditions--Pulse Width≤100μs and Duty≤1%.

*2:Soldering time≤5 seconds.

ELECTRICAL OPTICAL CHARACTERISTICS AT TA=25°C

Parameter	Symbol	Min.	Typ.	Max.	Unit	Test Condition
Forward Voltage	V_F	1.1	1.2		V	$I_F=20mA$
Radiant Intensity	I_e	7	10		mW/sr	$I_F=20mA$
Peak Wavelength	λ_P		940		nm	$I_F=20mA$
Reverse Current	I_R			10	μA	$V_R=5V$
Viewing Angle	θ		120		deg	$I_F=20mA$

Typical Electrical-Optical Characteristics Curves

Fig.1 Forward Current vs. Ambient Temperature

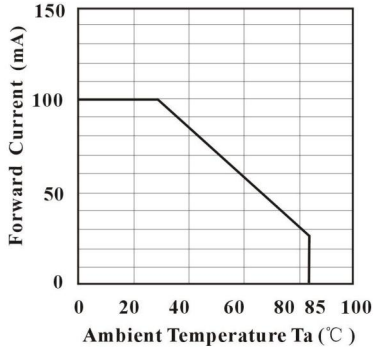

Fig.2 Spectral Sensitivity

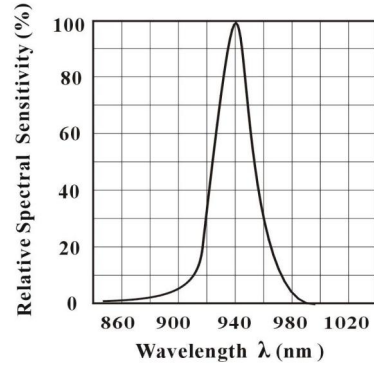

Fig.3 Peak Emission WaveLength vs. Ambient Temperature

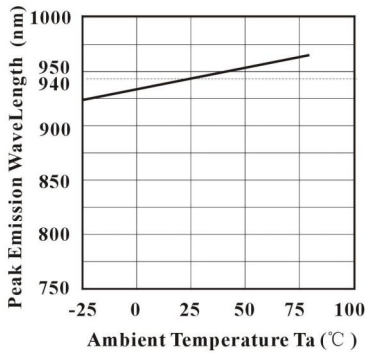

Fig.4 Forward Current vs. Forward Voltage

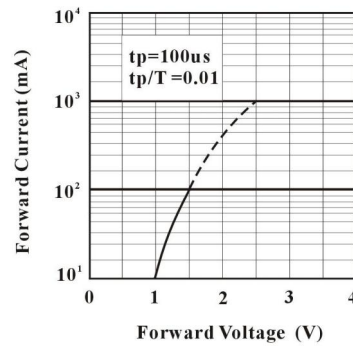

Fig.5 Relative Intensity vs. Forward Current

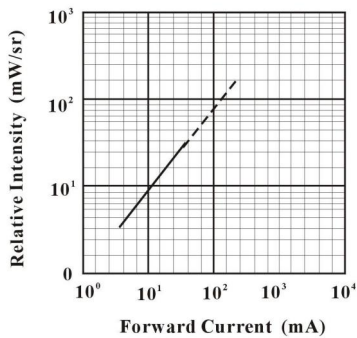
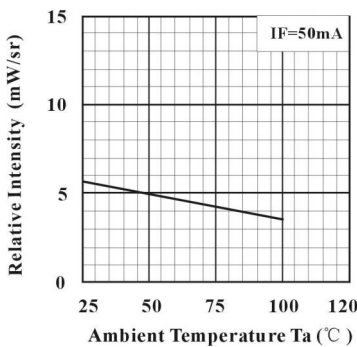

Fig.7 Relative Intensity vs. Ambient Temperature (°C)



Beam Patter

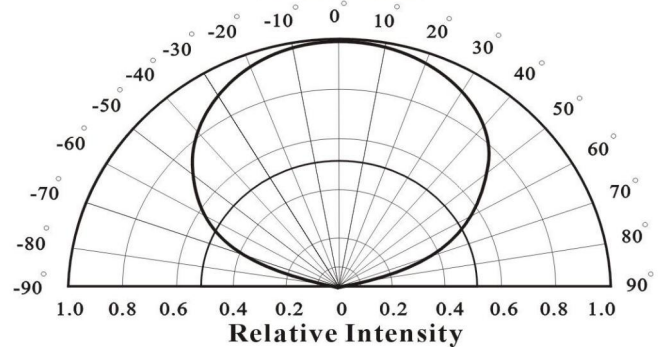
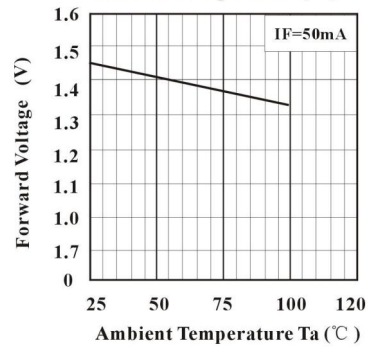

Fig.8 Forward Voltage vs. Ambient Temperature (°C)



Packing Quantity Specification

1. 1000Pcs/1Bag,8 Bag/1Box
2. 4Boxes/1Carton

Label Form Specification

製品名 PRODUCT	
コードNo. CODE No.	
数量 Q'TY	
ロットNo. LOT No.	
備考 REMARKS	
	

- PRODUCT: Part Number
- CODE NO.: Product Serial Number
- QTY: Packing Quantity
- LOT No: Lot Number
- REMARKS:Remarks

Notes**Lead Forming**

1. During lead formation, the leads should be bent at a point at least 3mm from the base of the epoxy bulb.
2. Lead forming should be done before soldering.
3. Avoid stressing the LED package during leads forming. The stress to the base may damage the LED's characteristics or it may break the LEDs.
4. Cut the LED lead frames at room temperature. Cutting the lead frames at high temperatures may cause failure of the LEDs.
5. When mounting the LEDs onto a PCB, the PCB holes must be aligned exactly with the lead position of the LED. If the LEDs are mounted with stress at the leads, it causes deterioration of the epoxy resin and this will degrade the LEDs.

Soldering

- Careful attention should be paid during soldering. When soldering, leave more than 3mm from solder joint to epoxy bulb, and soldering beyond the base of the tie bar is recommended.
- Recommended soldering conditions:

Hand Soldering		DIP Soldering	
Temp. at tip of iron	300°C Max. (30W Max.)	Preheat temp.	100°C Max. (60 sec Max.)
Soldering time	3 sec Max.	Bath temp. & time	260 Max., 5 sec Max
Distance	3mm Min.(From solder joint to epoxy bulb)	Distance	3mm Min. (From solder joint to epoxy bulb)

3. Recommended soldering profile

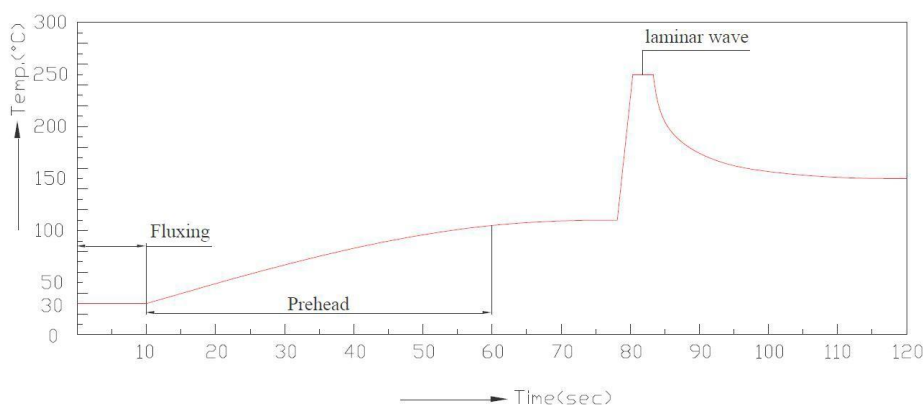

- Avoiding applying any stress to the lead frame while the LEDs are at high temperature particularly when soldering.
- Dip and hand soldering should not be done more than one time
- After soldering the LEDs, the epoxy bulb should be protected from mechanical shock or vibration until the LEDs return to room temperature.
- A rapid-rate process is not recommended for cooling the LEDs down from the peak temperature.
- Although the recommended soldering conditions are specified in the above table, dip or hand soldering at the lowest possible temperature is desirable for the LEDs.
- Wave soldering parameter must be set and maintain according to recommended temperature and dwell time in the solder wave.

Legal Disclaimer Notice

ALL PRODUCT, PRODUCT SPECIFICATIONS AND DATA ARE SUBJECT TO CHANGE WITHOUT NOTICE TO IMPROVE RELIABILITY, FUNCTION OR DESIGN OR OTHERWISE.

SIVAGO SEMICONDUCTOR CO.,LTD its affiliates, agents, and employees, and all persons acting on its or their behalf (collectively,“SIVAGO”), disclaim any and all liability for any errors, inaccuracies or incompleteness contained in any datasheet or in any other disclosure relating to any product.

SIVAGO makes no warranty, representation or guarantee regarding the suitability of the products for any particular purpose or the continuing production of any product. To the maximum extent permitted by applicable law, SIVAGO disclaims (i) any and all liability arising out of the application or use of any product, (ii) any and all liability, including without limitation special,consequential or incidental damages, and (iii) any and all implied warranties, including warranties of fitness for particular purpose, non-infringement and merchantability.

Statements regarding the suitability of products for certain types of applications are based on SIVAGO’s knowledge of typical requirements that are often placed on SIVAGO products in generic applications. Such statements are not binding statements about the suitability of products for a particular application. It is the customer’s responsibility to validate that a particular product with the properties described in the product specification is suitable for use in a particular application.Parameters provided in datasheets and / or specifications may vary in different applications and performance may vary over time. All operating parameters, including typical parameters, must be validated for each customer application by the customer’s technical experts. Product specifications do not expand or otherwise modify SIVAGO’s terms and conditions of purchase,including but not limited to the warranty expressed therein.

Except as expressly indicated in writing, SIVAGO products are not designed for use in medical, life-saving, or life-sustaining applications or for any other application in which the failure of the SIVAGO product could result in personal injury or death.Customers using or selling SIVAGO products not expressly indicated for use in such applications do so at their own risk.Please contact authorized SIVAGO personnel to obtain written terms and conditions regarding products designed for such applications.

No license, express or implied, by estoppel or otherwise, to any intellectual property rights is granted by this document or by any conduct of SIVAGO. Product names and markings noted herein may be trademarks of their respective owners.